

# eDRAWINGS USER GUIDE



# 1 User Guide: eDrawings Viewer

This User Guide will step you thru some of the basic eDrawings Viewer functionality. Its purpose is to get you up and running quick so you can use the Viewer to view SPX Waukesha models and drawings.

- 1) Begin by launching your eDrawings Viewer program.
- 2) Once the program is running, select: File/Open from the main menu. Locate the file you wish to open (for now, select the .eamsm file that accompanies this Guide).

You should now have an eDrawings assembly on your desktop. Practice manipulating the model using your mouse.

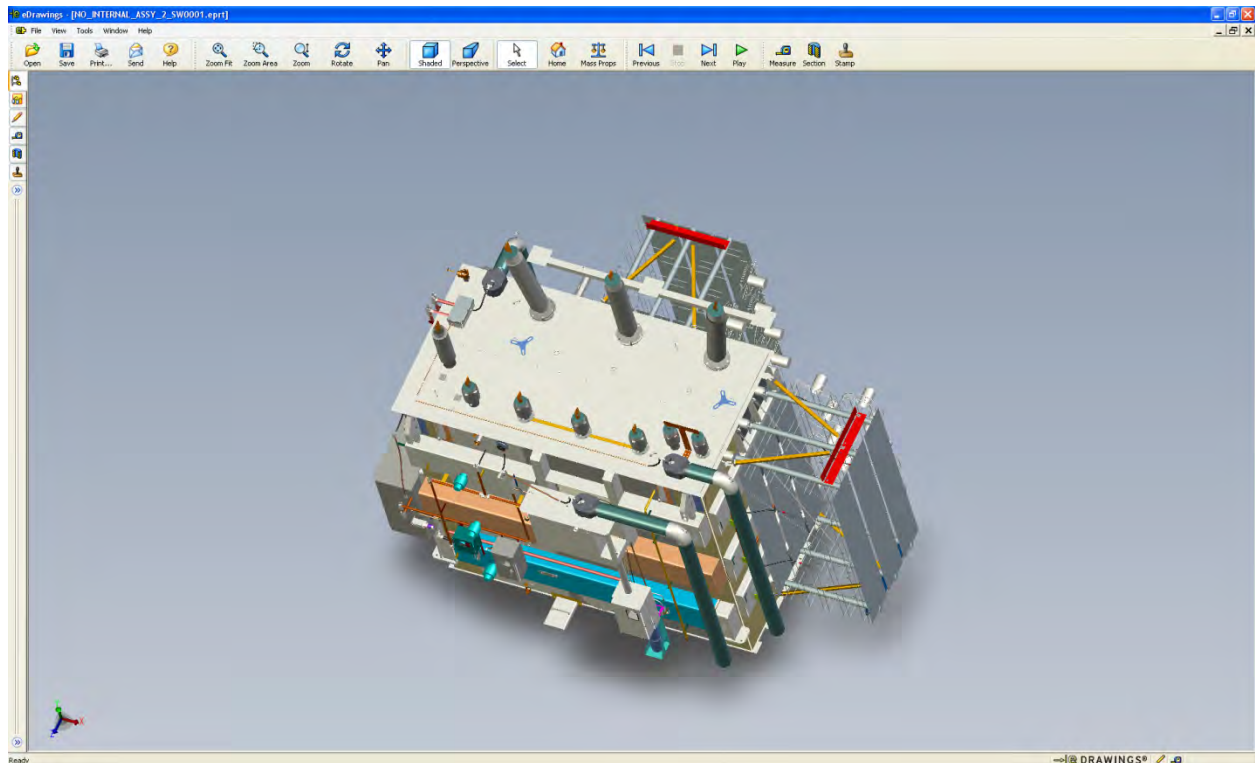

- **Spin the Model:** *press and hold the MMB (Middle Mouse Button) while moving the mouse on your desktop.*
- **Zoom the Model:** *if you have a click wheel, simply rotate the wheel back and forth. Otherwise hold the SHIFT key and hold down the MMB while you move the mouse up and down.*
- **Pan the Model:** *hold the CTRL key and hold down the MMB while you move the mouse.*

That's it! You can now manipulate the model however you like. Practice a little ...

## How to Get Dimensions

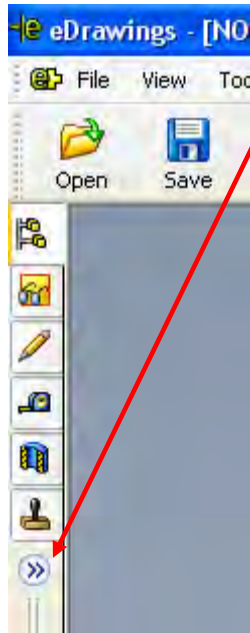

Figure 1

- 1) Open the sidebar by clicking the “arrow” icon (figure 1).
- 2) Press the “tape measure” icon to turn on dimensioning (figure 2).

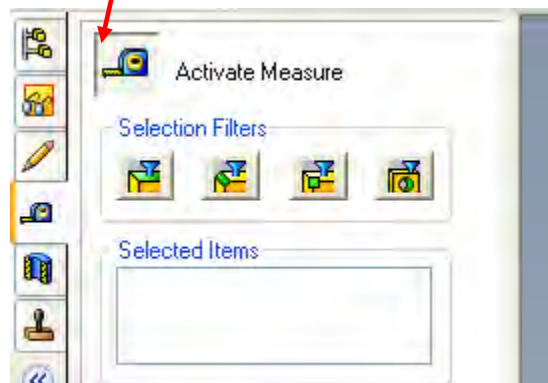
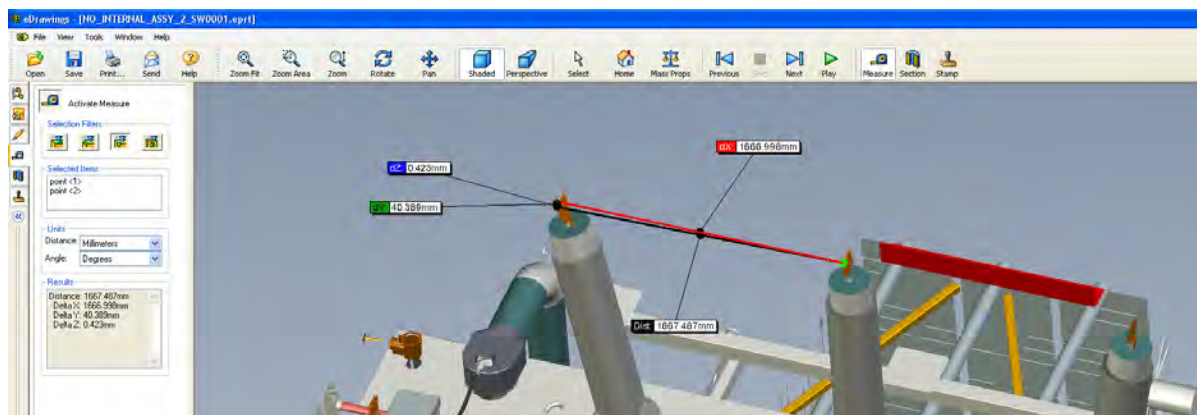

Figure 2

- You are now set up to use dimensioning!
- Apply a “selection filter” so you can easily select different model features. Filter choices include: faces, edges, vertices or holes.



- Simply click on the corresponding model features (face, edge, vertex or hole) and the viewer will report the dimensions.
- To clear your selection, click anywhere outside the model in the active window.
- Make sure you clear your selections between dimension picks. When in doubt, simply clear the entry and start over. Practice taking a few different types of dimensions ...

### How to Mark-Up a Drawing

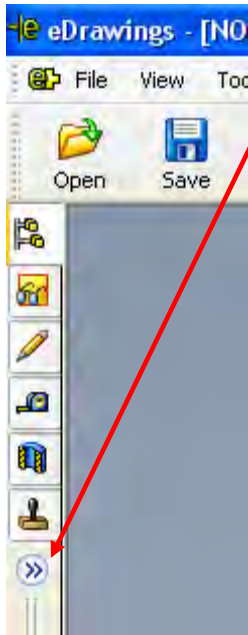

Figure 3

- 1) Open the sidebar by clicking the “arrow” icon (figure 3).
- 2) Press the “Pencil” icon to turn on mark-Up (figure 4).

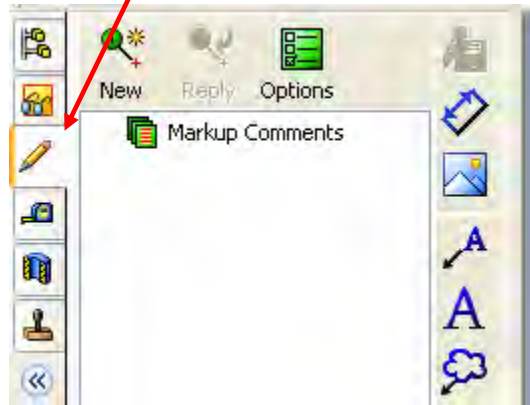

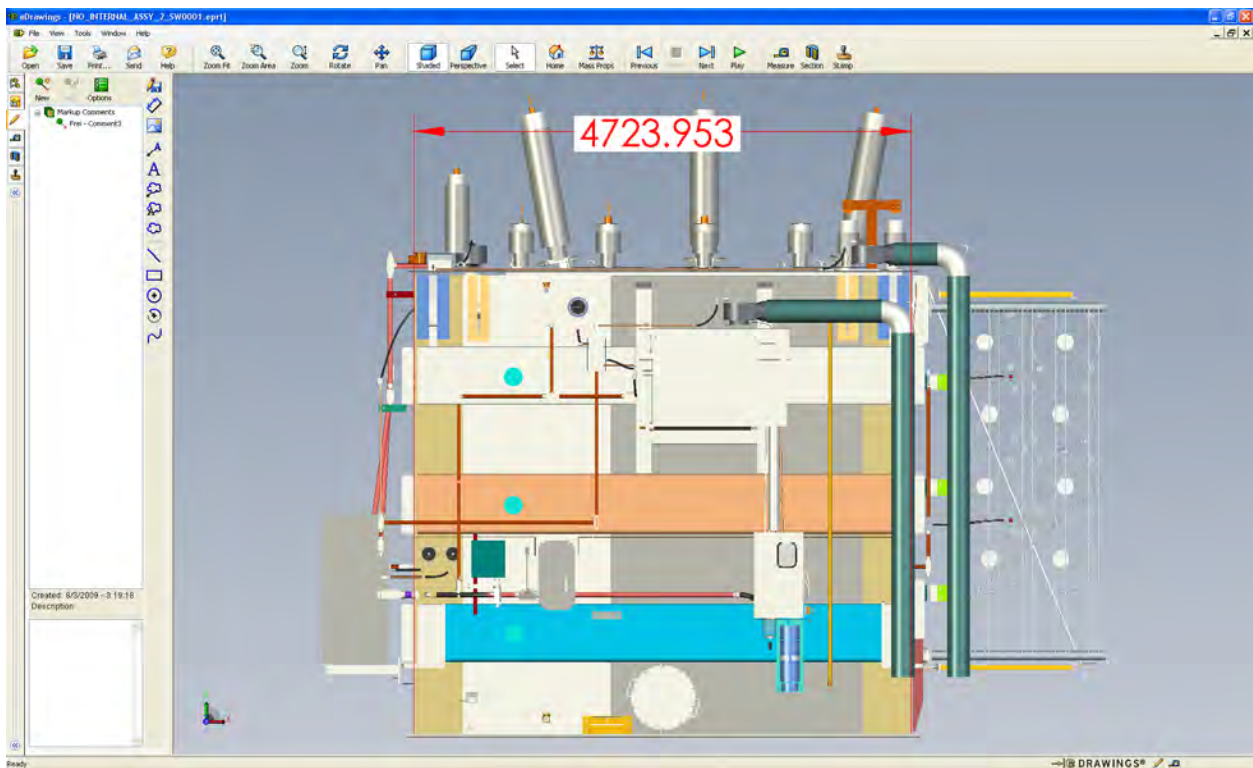

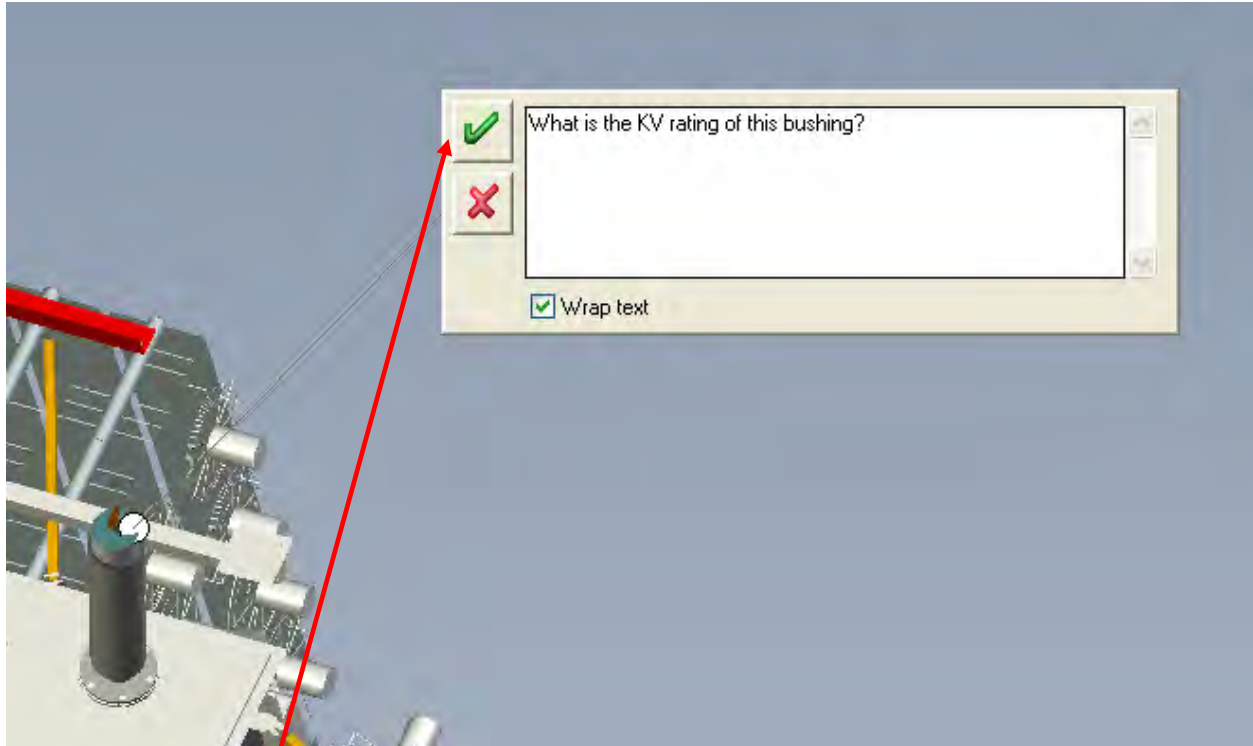

Figure 4

You have several mark-up tools to pick from. The “dimension” tool  allows you to mark-up a dimension on the model. Simply click it then select two reference points using the selection filter (described previously).



Of course you can also mark-up a model or drawing with notes. Simply select one of the text mark-up tools like  and then click on a model feature. A dialog box will open allowing you to enter your mark-up text.



Click the green check mark to accept your text.

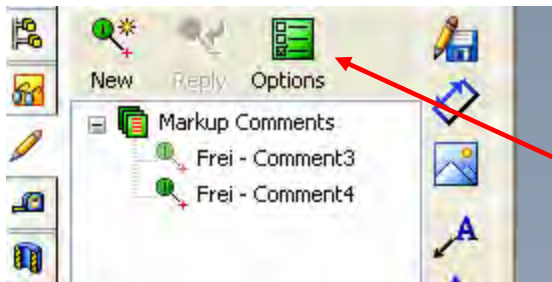

Note that your mark-ups are saved as individual comments. You can turn them on or off simply by selecting the comments in the tree.

Click on the “Options” icon. A dialog will open allowing you to customize your contact information.



Finally, you should click the save icon  (or select File/Save) to save your mark-ups. After saving your mark-ups, you are free to send your eDrawings file back to SPX Waukesha.

Go ahead and explore your eDrawings viewer. There is additional functionality you might find useful. Feel free to call SPX Waukesha if you have any questions.